



Spectra 12 Series Explosion Proof, Pressure and Differential Pressure Switches





UNITED ELECTRIC
CONTROLS

Installation and Maintenance Instructions

Please read all instructional literature carefully and thoroughly before starting. Refer to the final page for the listing of Recommended Practices, Liabilities and Warranties.

GENERAL

 MISUSE OF THIS PRODUCT MAY CAUSE EXPLOSION AND PERSONAL INJURY. THESE INSTRUCTIONS MUST BE THOROUGHLY READ AND UNDERSTOOD BEFORE UNIT IS INSTALLED.

 THIS EQUIPMENT IS SUITABLE FOR USE IN CLASS I, DIVISIONS 1 & 2, GROUPS A, B, C AND D; CLASS II, DIVISIONS 1 & 2, GROUPS E, F AND G; CLASS III; OR NON-HAZARDOUS LOCATIONS ONLY. $-50\text{ }^{\circ}\text{C}$ ($-58\text{ }^{\circ}\text{F}$) \leq Tamb. $\leq 95\text{ }^{\circ}\text{C}$ ($203\text{ }^{\circ}\text{F}$), ENCLOSURE TYPE 4X.

 THIS EQUIPMENT IS ATEX CERTIFIED (OPTION M419) FOR EQUIPMENT CATEGORY 2. SUITABLE FOR APPROPRIATE USE IN GAS ZONE 1 AND DUST ZONE 21 APPLICATIONS.

CE 0539 DEMKO 03 ATEX 0252466X

 II 2 G EEx d IIC T6

 II 2 D T+85 °C

$-50\text{ }^{\circ}\text{C} \leq$ Tamb. $\leq +80\text{ }^{\circ}\text{C}$, IP66

 BEFORE INSTALLING, CHECK THE SENSOR MODEL SELECTED FOR COMPATIBILITY TO THE PROCESS MEDIA IN CONTACT WITH THE SENSOR AND WETTED PARTS.

 PROOF PRESSURE* LIMITS STATED IN THE LITERATURE AND ON NAMEPLATES MUST NEVER BE EXCEEDED, EVEN BY SURGES IN THE SYSTEM. OCCASIONAL OPERATION OF UNIT UP TO PROOF PRESSURE IS ACCEPTABLE (E.G., START-UP, TESTING). CONTINUOUS OPERATION SHOULD NOT EXCEED THE DESIGNATED OVER RANGE PRESSURE.

*Proof Pressure

The maximum pressure to which a pressure sensor may be occasionally subjected, which causes no permanent damage (e.g., start-up testing). (May require set-point adjustment).

 THESE PRODUCTS DO NOT HAVE ANY FIELD REPLACEABLE PARTS. ANY SUBSTITUTION OF COMPONENTS MAY IMPAIR SUITABILITY FOR CLASS I, DIVISION 1.

The Spectra-12 switch utilizes a diaphragm or a piston sensor to detect a pressure change. The response, at a predetermined set point, actuates or deactuates a SPDT or DPDT snap-acting switch, converting a pressure signal into an electrical signal. Control set point may be varied by turning the internal slotted adjustment screw according to procedures outlined in Part II-Adjustments.

Part I - Installation

Tools Needed

1-1/6" Open end wrench

MOUNTING

 ALWAYS LOCATE UNITS WHERE SHOCK, VIBRATION AND AMBIENT TEMPERATURE FLUCTUATIONS ARE MINIMAL. DO NOT MOUNT IN AMBIENT TEMPERATURE AREAS EXCEEDING 203°F (IF UL/cUL APPROVAL IS APPLICABLE) OR 80 °F (IF ATEX APPROVAL IS APPLICABLE). IF SEVERE PRESSURE SURGES ARE EXPECTED, CONSIDER THE USE OF A PRESSURE SNUBBER.

 FOR PRESSURE MODELS, MOUNT USING PRESSURE CONNECTION: ALWAYS USE A WRENCH ON PRESSURE CONNECTION WRENCH FLAT. (SEE FIGURE 1)

MOUNT VIA
PRESSURE
CONNECTION

DO NOT TURN
SWITCH HOUSING

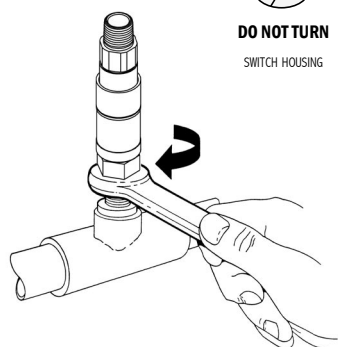



figure 1

 FOR DIFFERENTIAL PRESSURE MODELS, MOUNT UNIT AGAINST A RIGID SUPPORT USING THE MOUNTING BRACKET ATTACHED TO THE SENSOR ASSEMBLY. THEN CONNECT THE HIGH AND LOW PRESSURE CONNECTIONS (HIGH PRESSURE PORT IS ON THE LEFT, WHEN FACING THE UNIT).

 UNIT MAY BE MOUNTED IN ANY POSITION. HOWEVER, IF INSTALLATION LOCATION RESULTS IN FREQUENT EXPOSURE TO LIQUID IT IS RECOMMENDED THAT THE UNIT BE MOUNTED VERTICALLY WITH THE PRESSURE CONNECTION DOWN. IF UNIT IS TO BE SET AFTER MOUNTING, VERIFY THAT ADJUSTMENT OPENING IS ACCESSIBLE. "FRONT" MARKING ON NAMEPLATE MUST FACE THE OPERATOR.

1/2" NPTM or M20 Electrical Connection

When panel mounting, mount through 7/8" clearance hole in panel. Hold in place with serrated 1/2" or M20 conduit nut. Always support the unit by holding a wrench on the hex.

TO ATTACH CONDUIT CONNECTION, HOLD ELECTRICAL CONNECTION STEADY WITH WRENCH ON HEX, THEN THREAD ON CONDUIT.

Surface Mounting Bracket Kit (P/N 62169-13), Option M449

Open the adjustment cover and orient the unit so that adjustment opening will be accessible when the switch is mounted. Close the adjustment cover ensuring that the bracket does not interfere with the cover. Failure to do so may result in improper sealing of adjustment cover. Mount assembly in desired location, following instructions included with mounting bracket kit.

WIRING

 DISCONNECT ALL SUPPLY CIRCUITS BEFORE WIRING UNIT. ELECTRICAL RATINGS STATED IN LITERATURE AND ON NAMEPLATE MUST NOT BE EXCEEDED. OVERLOAD ON A SWITCH CAN CAUSE FAILURE ON THE FIRST CYCLE.

 EXTERNAL GROUNDING SCREW (OPTION M460) IS REQUIRED FOR NON-METALLIC CONDUIT SYSTEMS.

 WIRE IN ACCORDANCE WITH LOCAL AND NATIONAL ELECTRICAL CODES. BY THE INSTALLATION, THE WIRES SHALL BE PROTECTED AGAINST MECHANICAL DAMAGE. E.G. BY USE OF A CONDUIT.

 DIN CONNECTOR (OPTION M515) IS NOT APPROVED FOR CLASS I, DIV. 1/HAZARDOUS LOCATIONS/FLAMEPROOF ATMOSPHERES.

 THE WIRING TO THE PRESSURE SWITCH MUST ONLY BE CONNECTED IN THE SAFE AREA OR BY AN APPROVED TERMINAL BOX CERTIFIED TO EN 50 018 OR EN 50 019 FOR HAZARDOUS LOCATIONS/FLAMEPROOF ATMOSPHERES.

1/2" NPTM or M20 conduit connection is provided on top of the unit with 72" leadwires. Unit is available with SPDT or DPDT operation. External grounding screw and clamp is provided with option M460.

Factory Sealed Leadwires are color coded:

TERMINALS	SPDT	DPDT	
		SWT1	SWT2
Common	Brown	Brown	Yellow
Normally Closed	Red	Red	Black
Normally Open	Blue	Blue	Violet
Ground	Green	Green	

DIN Connector with 4 Male Terminals (figure 3)

Wire in accordance with local and national electrical codes. Connector conforms to DIN 43650. Use a mating DIN connector (female type). Coding:

TERMINALS

Terminal #1	Common
Terminal #2	Normally Closed
Terminal #3	Normally Open
	Ground

Part II - Adjustments

Tools Needed

Flathead screwdriver with 3/16" or 1/4" wide blade

1. Connect control to pressure source.
2. With power disconnected, slide cover toward electrical terminations while twisting it to over-come friction.
3. Connect power to terminals or leads.
4. Insert screwdriver into adjustment slot and turn **left** (clockwise) to **increase** setting or **right** (counterclock-wise) to **decrease** setting. (See figure 2).

For setting on RISE, apply desired pressure and turn adjustment left (clockwise) until switch clicks (circuit across N.O. and COM terminals closes).

For setting on FALL, apply pressure equal to normal system operating pressure. Reduce source pressure to setpoint value. Turn adjustment right (counter clockwise) until switch clicks (circuit across N.C. and COM terminals closes).

Dimensions

Standard Configuration

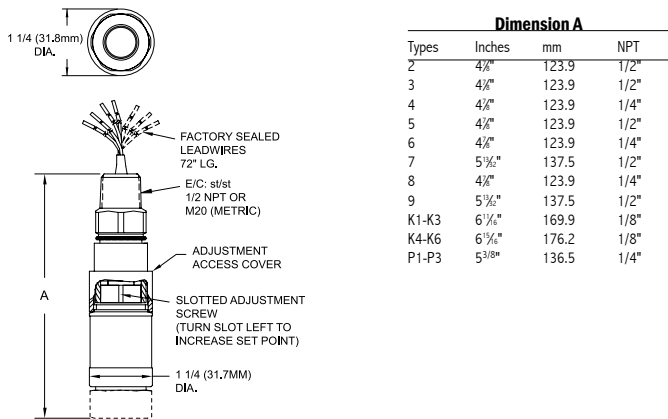
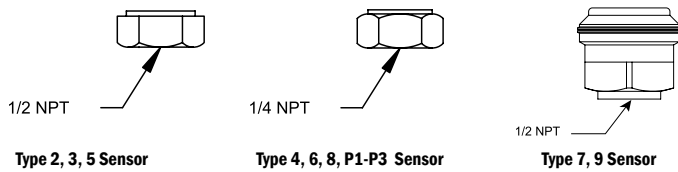
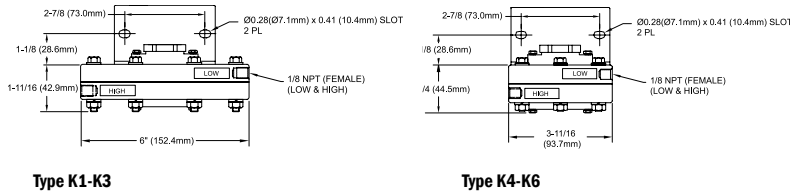

figure 2

Pressure



Differential Pressure



Type K1-K3

Type K4-K6

Types K1-K3 and K4-K6 shown with mounting bracket attached

Option M515 DIN Connection

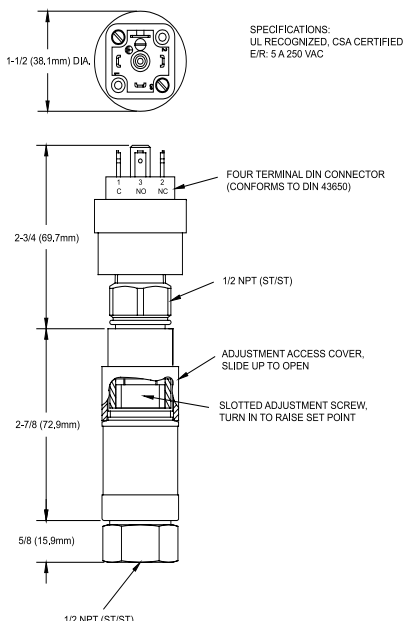

figure 3

RECOMMENDED PRACTICES AND WARNINGS

United Electric Controls Company recommends careful consideration of the following factors when specifying and installing UE pressure and temperature units. Before installing a unit, the Installation and Maintenance instructions provided with unit must be read and understood.

- To avoid damaging unit, proof pressure and maximum temperature limits stated in literature and on nameplates must never be exceeded, even by surges in the system. Operation of the unit up to maximum pressure or temperature is acceptable on a limited basis (e.g., start-up, testing) but continuous operation must be restricted to the designated adjustable range. Excessive cycling at maximum pressure or temperature limits could reduce sensor life.
- A back-up unit is necessary for applications where damage to a primary unit could endanger life, limb or property. A high or low limit switch is necessary for applications where a dangerous runaway condition could result.
- The adjustable range must be selected so that incorrect, inadvertent or malicious setting at any range point cannot result in an unsafe system condition.
- Install unit where shock, vibration and ambient temperature fluctuations will not damage unit or affect operation. Orient unit so that moisture does not enter the enclosure via the electrical connection. When appropriate, this entry point should be sealed to prevent moisture entry.
- Unit must not be altered or modified after shipment. Consult UE if modification is necessary.
- Monitor operation to observe warning signs of possible damage to unit, such as drift in set point or faulty display. Check unit immediately.
- Preventative maintenance and periodic testing is necessary for critical applications where damage could endanger property or personnel.
- For all applications, a factory set unit should be tested before use.
- Electrical ratings stated in literature and on nameplate must not be exceeded. Overload on a switch can cause damage, even on the first cycle. Wire unit according to local and national electrical codes, using wire size recommended in installation sheet.
- Do not mount unit in ambient temp. exceeding published limits.

LIMITED WARRANTY

Seller warrants that the product hereby purchased is, upon delivery, free from defects in material and workmanship and that any such product which is found to be defective in such workmanship or material will be repaired or replaced by Seller (Ex-works, Factory, Watertown, Massachusetts, INCOTERMS); provided, however, that this warranty applies only to equipment found to be so defective within a period of 36 months from the date of manufacture by the Seller. Seller shall not be obligated under this warranty for alleged defects which examination discloses are due to tampering, misuse, neglect, improper storage, and in any case where products are disassembled by anyone other than authorized Seller's representatives. EXCEPT FOR THE LIMITED WARRANTY OF REPAIR AND REPLACEMENT STATED ABOVE, SELLER DISCLAIMS ALL WARRANTIES WHATSOEVER WITH RESPECT TO THE PRODUCT, INCLUDING ALL IMPLIED WARRANTIES OF MERCHANTABILITY OR FITNESS FOR ANY PARTICULAR PURPOSE.

LIMITATION OF SELLER'S LIABILITY

Seller's liability to Buyer for any loss or claim, including liability incurred in connection with (i) breach of any warranty whatsoever, expressed or implied, (ii) a breach of contract, (iii) a negligent act or acts (or negligent failure to act) committed by Seller, or (iv) an act for which strict liability will be inputed to seller, is limited to the "limited warranty" of repair and/or replacement as so stated in our warranty of product. In no event shall the Seller be liable for any special, indirect, consequential or other damages of a like general nature, including, without limitation, loss of profits or production, or loss or expenses of any nature incurred by the buyer or any third party.

UE specifications subject to change without notice.



UNITED ELECTRIC CONTROLS

180 Dexter Avenue, P.O. Box 9143
 Watertown, MA 02471-9143 USA
 Telephone: 617 926-1000 Fax: 617 926-2568
<http://www.ueonline.com>